

The synergy of wide experience, research and development for your success and benefit.

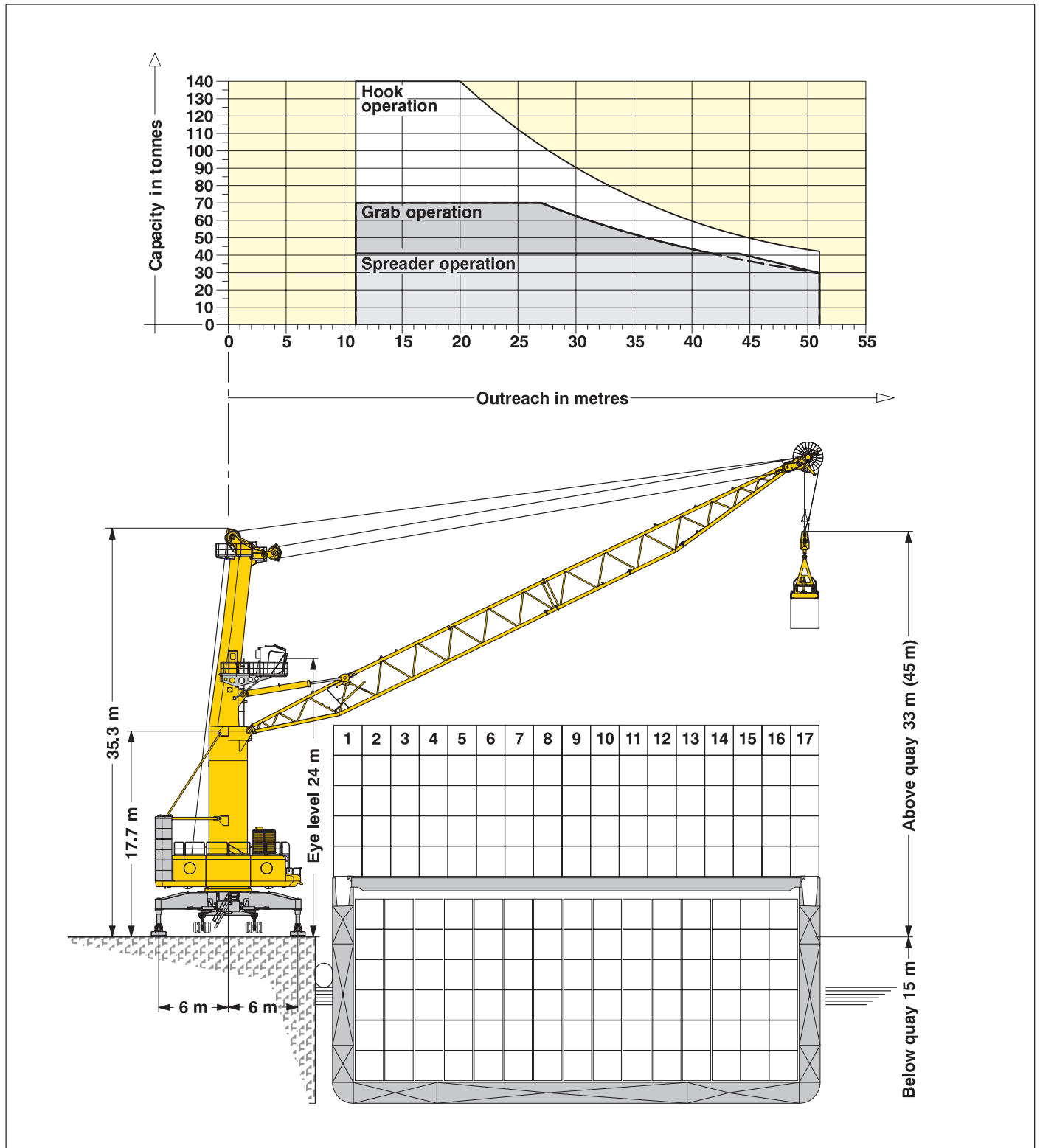

8900 573 14 -05/2005 Subject to change without notice.

Liebherr harbour mobile crane

Type LHM 500 Litronic®

- utmost performance
- high reliability and quality
- low operational costs
- unsurpassed mobility and versatility
- worldwide service network

Radius	Hook operation	Spreader operation	Grab operation
(m)	(t)	(t)	(t)
11	140.0	41.0	70.0
20	140.0	41.0	70.0
21	137.5	41.0	70.0
22	130.5	41.0	70.0
23	123.9	41.0	70.0
24	117.9	41.0	70.0
25	112.3	41.0	70.0
26	107.2	41.0	70.0
27	102.5	41.0	70.0
28	97.7	41.0	69.5
29	93.3	41.0	66.3
30	89.2	41.0	63.4
31	85.6	41.0	60.9
32	82.4	41.0	58.6
33	79.2	41.0	56.3
34	76.1	41.0	54.1
35	73.2	41.0	52.0
36	70.4	41.0	50.1
37	67.9	41.0	48.3
38	65.6	41.0	46.6
39	63.4	41.0	45.1
40	61.2	41.0	43.5
42	57.2	41.0	40.7
44	53.5	41.0	38.1
46	50.2	37.7	35.7
48	47.1	34.6	33.5
50	43.7	31.2	31.1
51	42.2	29.7	30.0

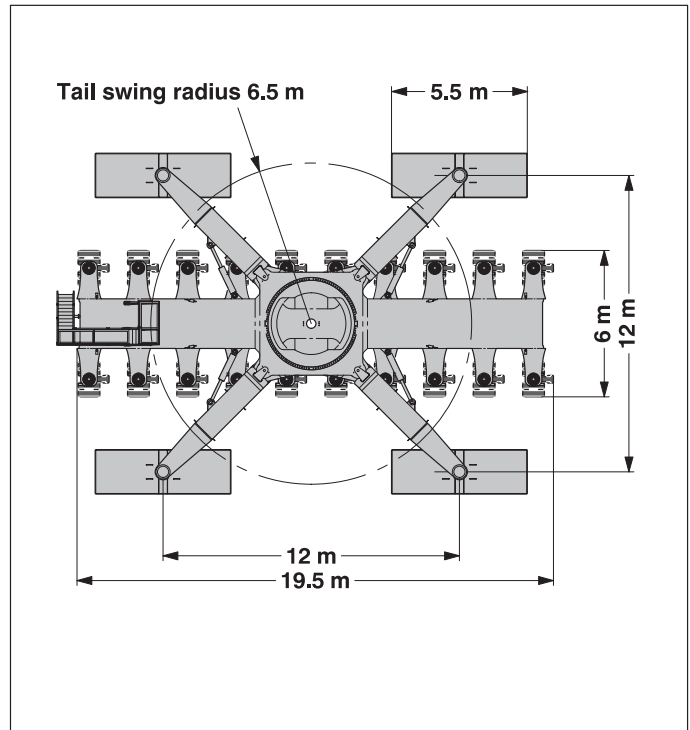

Capacities

Standard operation	104 t
Heavy lift operation	140 t

Main dimensions

Min to max. outreach	11 – 51 m
Height of boom fulcrum	17.7 m
Tower cabin height (eye level)	24 m

Hoisting heights

Above quay at minimum radius	45 m
Above quay at maximum radius	33 m
Below quay	15 m

Working speeds

Hoisting / lowering	0 – 90 m/min
Slewing	0 – 1.6 rpm
Luffing	0 – 100 m/min
Travelling	0 – 90 m/min

Quay load arrangements

Uniformly Distributed Load	2.4 t/m ²
Max. load per tyre	6.0 t

Due to its unique travelling and supporting system, the parameters of the undercarriage (pad sizes, supporting base and number of axle sets) can easily be adapted to comply with the most stringent quay load restrictions.

Weights

Weight of the crane	305 t
Counterweight	150 t
Total weight of the crane	approx. 455 t

Propping arrangements

Standard supporting base	12 m x 12 m
Standard pad dimension	4x 5.5 m x 1.8 m